



# NORHAM FLEXIBLE COUPLINGS SC

C O U P L I N G S & S E A L S

Connection and repair multimaterial couplings, with water flow preservation, for all sewerage, rainwater and backflow networks.

- **Multimaterial** : connects pipes, materials, and different diameters..
- Suitable for **above or below ground applications, inside or outside** buildings.
- **Completely watertight** : withstands pressures up to 1.0 bar.
- **Manufactured and certified in France** : DTA N°17.2/20-352\_V2 and ETA-09/0248.



Z.A DRUISIEUX - 130 RUE DES SAULES, 26260 SAINT DONAT SUR L'HERBASSE - FRANCE  
TÉL : 33 (0) 4 75 45 00 00 - norham@norham.fr // www.norham.fr



# NORHAM FLEXIBLE COUPLINGS SC

## COUPLINGS & SEALS



## CONTENTS

<b>INTRODUCTION</b> .....	<b>4</b>
AREA OF USE .....	4
TECHNICAL DATA .....	5
CERTIFICATIONS AND TESTS .....	6
<b>THE RANGE</b> .....	<b>8</b>
FLOW CHART .....	8
WHAT IS SHEARING? .....	9
SPECIAL PVC WATER FLOW CONTINUITY .....	9
WHAT IS THE $\Delta$ MAX. ? .....	9
<b>COUPLINGS REINFORCED WITH ANTI-SHEARING BANDS</b> .....	<b>10</b>
NORHAM FLEXIBLE COUPLINGS SC .....	10
<b>OTHER TECHNICAL INFORMATION</b> .....	<b>12</b>
APPLICATION TO HELP DEFINE COUPLINGS .....	12
INSTALLATION AND USE .....	13
COUPLINGS : COMMON PRODUCTS .....	14
CORRESPONDENCES BETWEEN DN AND EXTERNAL DIAMETERS .....	16
CASE STUDY .....	18
OTHER NORHAM SOLUTIONS .....	19

# NORHAM FLEXIBLE COUPLINGS SC

## COUPLINGS & SEALS

### → INTRODUCTION

Since its creation in 1989, NORHAM has specialised in the design, development and manufacture of products and solutions for the water and sanitation sectors. NORHAM became known particularly for its **NORHAM FLEXIBLE COUPLINGS** multimaterial couplings designed for connecting and repairing pipes in gravity networks.

In 1997, **NORHAM FLEXIBLE COUPLINGS** obtains the first Technical Assessment issued by CSTB for "*flexible elastomeric couplings, with or without stainless steel reinforcement bands, designed to assemble different types of sanitation pipelines.*"

In 2009, **NORHAM FLEXIBLE COUPLINGS** obtained the first European Technical Approval issued by EOTA.

Through these certifications, NORHAM consistently strives

(1) No. 006352787 issued by the European Office for Intellectual Property.

to attest to the quality, reliability, and performance of its **NORHAM FLEXIBLE COUPLINGS**.

In 2020, NORHAM completed and renewed its production facilities and **NORHAM FLEXIBLE COUPLINGS** became the only couplings CERTIFIED AND MADE IN FRANCE.

They also have a Community registration<sup>(1)</sup> for their unique design.

More than 30 years of NORHAM history and millions of **NORHAM FLEXIBLE COUPLINGS** installed by professionals are references and recommendations that feed NORHAM's experience and are sources of inspiration for our future developments.

### AREA OF USE

**NORHAM FLEXIBLE COUPLINGS** multimaterial couplings have been designed to connect pipes of different diameters and materials and all types of equipment with tubular connections (e.g., end-of-pipe valves, manholes, etc.).

**NORHAM FLEXIBLE COUPLINGS** have a soft, flexible elastomer sleeve.

The two stainless steel clamps are used to secure the sleeve to the pipes, ensuring that the sewerage, rainwater and backflow networks are perfectly watertight.

**NORHAM FLEXIBLE COUPLINGS** multimaterial couplings are quick and easy to install. All you need is a screwdriver or ratchet spanner. They can be installed above or below ground, inside or outside buildings.



# NORHAM FLEXIBLE COUPLINGS SC

## COUPLINGS & SEALS

### TECHNICAL DATA

- **Pressure resistance :**
  - \* **LC et XLC couplings :** max. 1,0 bar ;
  - \* **SC et XL couplings :** max. 1,0 bar ;
  - \* **AC et DC couplings :** max. 0,6 bar.
- **Test pressure :**
  - \* **LC et XLC couplings :** max. 1,0 bar ;
  - \* **SC et XL couplings :** 1,5 bars ;
  - \* **AC et DC couplings :** 0,6 bar.
- **Temperature resistance :** -40 °C à +140 °C ;
- **Angular deflection :** see table below. For extreme conditions, please contact us.

Requirement for gravity flow in accordance with European Standard EN 476 = 0.5 bar.

	DN	MAX. ANGULAR DEFLECTION
SC / XL	DN ≤ 200	5,0° (80 mm/m)
	200 < DN < 500	2,0° (30 mm/m)
	DN ≥ 500	1,5° (20 mm/m)
AC / DC	DN ≤ 200	7,5° (120 mm/m)
	200 < DN ≤ 500	3,0° (45 mm/m)

### ASSEMBLY TECHNOLOGY

- **TOX® :** assembly of parts in AISI 304 stainless steel (or AISI 316 stainless steel), without the addition of material, by clinching (deep-drawing process) for optimum corrosion resistance (SC and XL couplings) ;
- **CLIP-IN :** a profiled system in the rubber that holds the clamps and the central anti-shearing band in place for easier handling and installation (SC, DC and AC couplings). ;
- **MEDIUM-TORQUE and HI-TORQUE :** optimum clamping system for guaranteed pressure resistance :
  - \* **MEDIUM-TORQUE :** all AC, DC and SC couplings up to 200 mm diameter ;
  - \* **HI-TORQUE :** SC from diameter 200 mm and all XL couplings ;
  - \* **T-BOLT :** clamping system for optimum pressure resistance for all LC and XLC couplings.

### MATERIALS QUALITY

Materials have been selected for their performance. AISI 304 and AISI 316 stainless steels offer excellent corrosion resistance, while EPDM is highly resistant to the main effluents.

For all special applications (industrial fluids, chlorinated fluids, etc.), consult NORHAM's technical department.

- **EPDM elastomer** in compliance with standard **NF EN 681-1**, or nitrile rubber as an option ;
- **AISI 304 stainless steel** with a minimum hardness corresponding to class **+C850** in accordance with standard **NF EN 10088-2** (AISI 316 stainless steel optional).

The strain-hardened stainless steel of the **anti-shear reinforcement band**, through rolling, increases the yield strength and hardness of the stainless steel and confers a memory effect on the coupling, giving it high resistance to shear load: **25 x DN** (in Newton, N).

**NORHAM FLEXIBLE COUPLINGS** comply with the following standards :

- **NF-EN 476 :** general requirements for components used for sewerage connections and collectors ;
- **NF-EN 13501-1 :** fire classification of construction elements ;
- **NF-EN 10088-2 :** characteristics of stainless steels ;
- **NF-EN 681-1 :** specifications for elastomers used in pipe couplings and seals.

All the requirements of these standards, as well as those relating to the performance of couplings, are set out in our Technical Approvals and certifications (see p. 6).

# NORHAM FLEXIBLE COUPLINGS SC

## COUPLINGS & SEALS

### CERTIFICATIONS AND TESTS

#### CERTIFICATIONS BY BODIES

NORHAM COUPLINGS multimaterial couplings are the only ones manufactured and certified in France.

They have :

- European Technical Assessment ETA n° 09/0248 (issued by EOTA);
- a Technical Notice : Technical application document DTA n° 17.2/20-352\_V2 (issued by the CSTB).

As part of our DTA / ETA, tests are carried out on our NORHAM COUPLINGS solutions to certify that the performance of our products complies with current requirements :

- sizing inspection ;
- watertightness of pipe coupling assemblies with :
  - short and long-term shear strength ;
  - angular deviation ;
  - pipe ovality ;
  - temperature cycling ;
  - fire resistance.



DOCUMENTS AVAILABLE ON REQUEST  
OR DOWNLOADABLE FROM OUR WEBSITE  
[WWW.NORHAM.FR](http://WWW.NORHAM.FR).

Thanks to these certifications, NORHAM COUPLINGS are et marked.





# NORHAM FLEXIBLE COUPLINGS SC

## COUPLINGS & SEALS

### PERFORMANCE TEST PERFORMED BY THE CSTB



Tests carried out on NORHAM FLEXIBLE COUPLINGS SC as part of our certification process. Test report available on request.

### TESTS ON NORHAM TEST BENCH

To ensure the consistent quality of its products and their durability over time, NORHAM tests its **NORHAM FLEXIBLE COUPLINGS** under extreme conditions on its test benches (in addition to the tests carried out by the CSTB).

Leak test : **NORHAM FLEXIBLE COUPLINGS** are fitted to pipes and subjected to water pressure of up to 1.5 bars. If no leakage is detected, the test is validated.

Shear strength test : **NORHAM FLEXIBLE COUPLINGS** are fitted to pipes and pressurised to 1.5 bar for 30 minutes, a shear load (in N) equal to 25 x DN is applied to the coupling. If no leakage is detected, the test is validated.



Shear strength test on a NORHAM FLEXIBLE COUPLINGS SC445. The same type of test is applied to all the couplings in the NORHAM FLEXIBLE COUPLINGS range.

# NORHAM FLEXIBLE COUPLINGS SC

## COUPLINGS & SEALS

### → THE RANGE

This flow chart will help you choose the most appropriate coupling from the **NORHAM FLEXIBLE COUPLINGS** range. To do this, check the following points:

- is the configuration underground (see **A**) or above ground (see **B**)?
- is there a risk of shearing (see **1**)?
- is there a PVC coupling to another material (see **2**)?
- is there a large difference between the two outside diameters (see **3**)?

#### A UNDERGROUND LAYING



#### B ABOVE-GROUND INSTALLATION

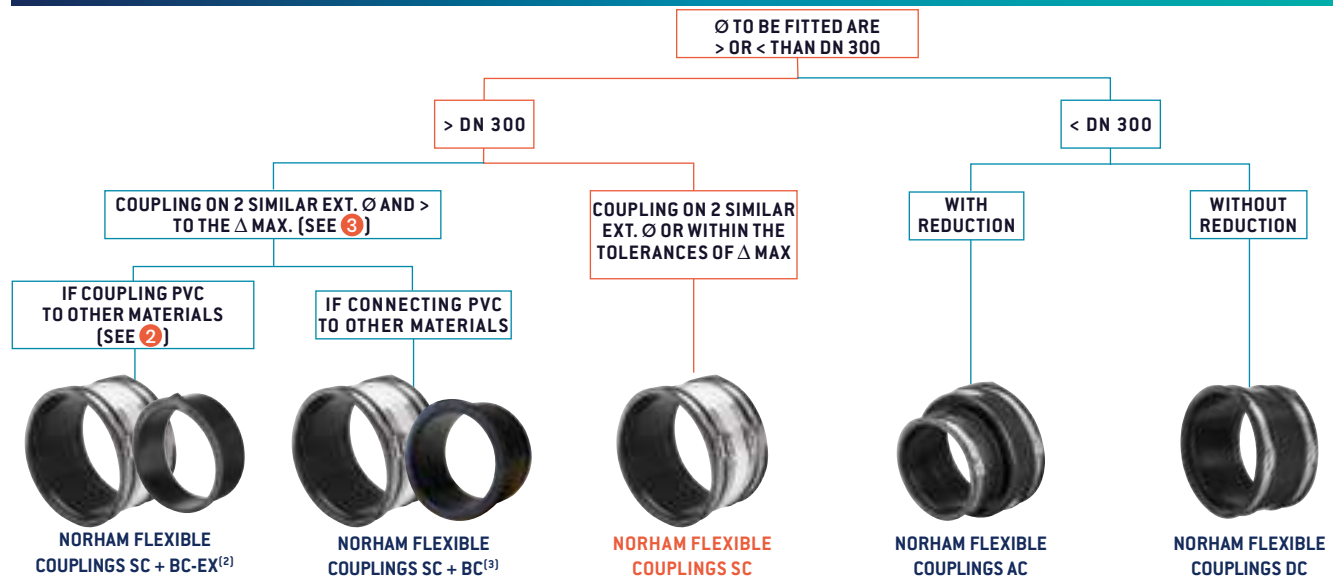

(1) The width of the coupling may vary depending on the part number. See table on p.11.

(2) If the maximum  $\Delta$  with a BC-EX ring is still greater than the maximum permitted  $\Delta$ , CR rings can be added.

(3) BC and BC-EX compensating rings can only be combined with NORHAM FLEXIBLE COUPLINGS SC, XL, LC and XLC.



# NORHAM FLEXIBLE COUPLINGS SC

## COUPLINGS & SEALS

### 1 WHAT IS SHEARING ?

When pipes are buried, they are subject to shearing stresses due to movement, ground settlement, rolling loads, etc. This can lead to damage to the pipe.

This can lead to the pipe cracking or breaking.

This can be repaired with our NORHAM FLEXIBLE COUPLINGS SC, XL, XLC and LC, which are equipped with anti-shear bands.

Example of ground shearing and solution:

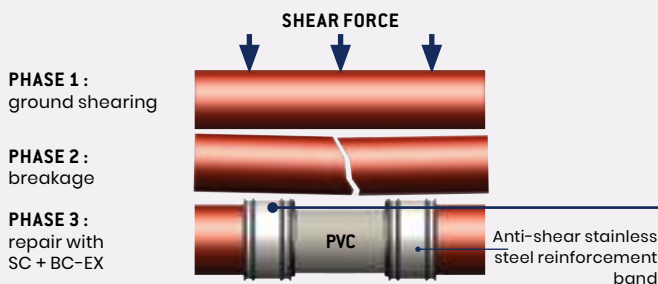

### 2 SPECIAL PVC WATER FLOW CONTINUITY<sup>(1)</sup>

When multimaterial couplings include a PVC pipe, the internal diameters (int.  $\varnothing$ ) are not identical (depending on the DN).

In this case, an eccentric compensation ring is required to maintain the water flow.

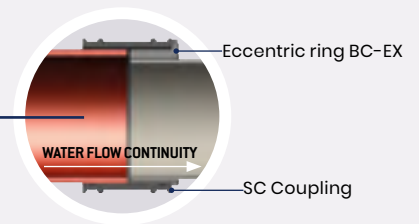

(1) Requirements defined in standard NF-EN476 "General requirements for components used in sewerage connections and collectors".

### 3 WHAT IS $\Delta$ MAX. ?

The  $\Delta$  max. is the difference between the external diameters (ext.  $\varnothing$ ) of the two pipes to be fitted. To make a connection with just one coupling, the difference between the external diameters (ext.  $\varnothing$ ) of the pipes must be less than the coupling's  $\Delta$  max.

If the difference between the two diameters is greater than the maximum  $\Delta$  of the coupling, compensation rings are required.

#### EXAMPLE 1 :

The difference between the two external diameters is less than the maximum  $\Delta$  of the coupling.

$\Delta$  MAX. :

- Difference in  $\varnothing$  ext. : 170 mm - 160 mm =  $\Delta$  10 mm ;
- $\Delta$  max. of SC175 = 12 mm  $\rightarrow$  does not require the use of a ring ;
- Complete assembly : SC175.

#### $\Delta$ MAX TABLE

SC / XL / LC / XLC CONNECTIONS	MAX. $\Delta$
$\varnothing$ ext. $\leq$ 120 mm	10 mm
120 mm $<$ $\varnothing$ ext. $<$ 300 mm	12 mm
$\varnothing$ ext. $\geq$ 300 mm	15 mm

#### EXAMPLE 2 :

The difference between the two external diameters is higher than the maximum  $\Delta$  of the coupling.

$\Delta$  MAX. :

- Difference in  $\varnothing$  ext. : 400 mm - 315 mm =  $\Delta$  85 mm ;
- $\Delta$  max. of XL410 = 15 mm  $\rightarrow$  require the use of compensation rings ;
- Complete assembly : XL410 + BC16-315-100 + BC24-347-100 ;
- $\Delta$  Final with compensation : 5 mm.

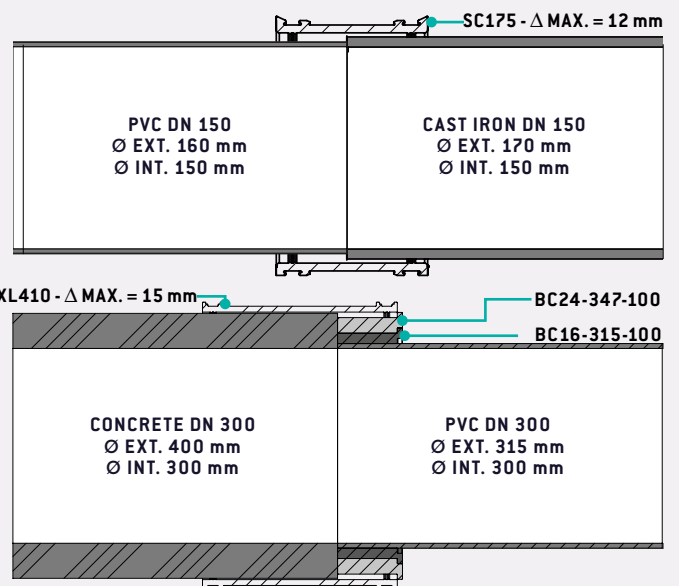

Compliance with the  $\Delta$  max. ensures that the coupling retains all its performance in terms of pressure resistance, shearing stress, ovality, etc.

# NORHAM FLEXIBLE COUPLINGS SC

## COUPLINGS & SEALS

### → COUPLINGS REINFORCED WITH ANTI-SHEARING BANDS

#### NORHAM FLEXIBLE COUPLINGS SC

##### AREA OF USE

Multimaterial **NORHAM FLEXIBLE COUPLINGS SC** are equipped with an anti-shear bands. They can be used to connect and repair pipes of similar or different materials and diameters for underground or overhead networks. They can be installed inside or outside buildings.

##### TECHNICAL DATA

- **Multimaterial couplings:** PVC, PP, smooth or corrugated HDPE, GRP, cast iron, fibre cement, steel, clay, concrete ;
- **Pressure-resistance :** up 1,0 bar ;
- **Test pressure :** 1,5 bars ;
- **Temperature resistance :** -40 °C to +140 °C ;
- **Angular deflection :** 1,5° to 5,0° depending on DN (see p. 5) ;
- **Shear strength :** 25 x DN (in N). For example : DN 200 x 25 = 5000 N, approximatively 500 kg ;
- **Fire resistance :** class E (NF-EN 13501-1).



##### MATERIALS

- **Sleeve** : made of EPDM 60 IRHD grade WG complying with standard NF-EN 681-1 (NBR option for DN ≥ 300 mm) ;
- **Anti-shear bands and fixing collars** : in AISI 304 stainless steel, with a minimum hardness corresponding to class +C850, in compliance with standard NF-EN 10088-2 (AISI 316 stainless steel option for DN ≥ 300 mm).

##### ASSEMBLY TECHNOLOGY

- **TOX®** : assembly of AISI 304 stainless steel fasteners (AISI 316 stainless steel option for DN ≥ 300 mm) on the anti-shear band, without any additional material, by clinching (a joining process) for optimum corrosion resistance ;
- **CLIP-IN** : a profiled system in the rubber that holds the clamps and the central anti-shear band in place, making them easier to handle and install ;
- **MEDIUM-TORQUE and HI-TORQUE** : optimum clamping system for guaranteed pressure resistance :
  - \* **MEDIUM-TORQUE** : all couplings up to 200 mm diameter ;
  - \* **HI-TORQUE** : from diameter 200 mm.

# NORHAM FLEXIBLE COUPLINGS SC

## COUPLINGS & SEALS

### SC RANGE FROM DN 50 TO DN 600

REF.	RANGE OF USE		$\Delta$ MAX. <sup>(1)</sup>	L	TIGHT. TORQUE
	SIDE A	SIDE B			
SC65	50-65	50-65	5	100	6
SC75	65-75	65-75	5	100	6
SC90	75-90	75-90	8	100	6
SC100	85-100	85-100	8	100	6
SC115	100-115	100-115	10	120	6
SC120	105-120	105-120	10	120	6
SC140	120-140	120-140	10	120	6
SC150	130-150	130-150	10	120	6
SC162	137-162	137-162	10	120	6
SC175	150-175	150-175	10	120	6
SC190	165-190	165-190	12	120	6
SC200	175-200	175-200	12	150	10
SC210	187-210	187-210	12	150	10
SC225	200-225	200-225	12	150	10
SC250	225-250	225-250	12	150	10
SC275	250-275	250-275	12	150	10
SC290	265-290	265-290	12	150	10
SC310	285-310	285-310	15	190	10
SC320	295-320	295-320	15	190	10
SC335	310-335	310-335	15	190	10
SC350	325-350	325-350	15	190	10
SC365	340-365	340-365	15	190	10
SC385	355-385	355-385	15	190	10
SC410	385-410	385-410	15	190	15
SC430	400-430	400-430	15	190	15
SC445	415-445	415-445	15	190	15
SC465	435-465	435-465	15	190	15
SC490	460-490	460-490	15	190	15
SC495	465-495	465-495	15	190	15
SC510	480-510	480-510	15	190	15
SC525	495-525	495-525	15	190	15
SC545	515-545	515-545	15	190	15
SC550	525-550	525-550	15	190	15
SC560	530-560	530-560	15	190	15
SC570	545-570	545-570	15	190	15
SC585	550-585	550-585	15	190	15
SC600	570-600	570-600	15	190	15
SC620	590-620	590-620	15	190	15
SC635	605-635	605-635	15	190	15
SC645	615-645	615-645	15	190	15

Regulatory requirements  
ATE n° 09/0248  
DTA n° 17.2/20-352\_V2

W<sub>p</sub>: 1,0 bar  
Test pressure: 1,5 bars

**NORHAM**  
Internal tests

W<sub>p</sub>: 2,5 bars

Test reports on request.

### FROM SC65 TO SC290

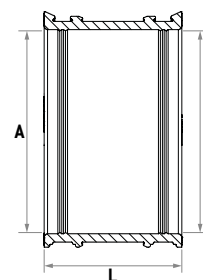

### SC310 AND MORE

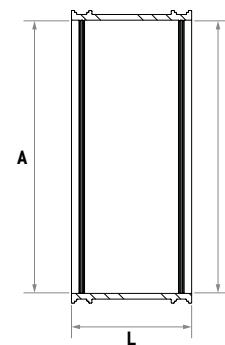

(1) See "What is the  $\Delta$  max?" on page 9.

### EXAMPLE OF COUPLING WITH CONTINUOUS WATER FLOW

PVC DN 150 EXTERNAL DIAMETER (EXT.Ø) 160 MM

TO CAST IRON DN 150 EXTERNAL DIAMETER (EXT.Ø) 170 MM

$\Delta$  MAX.:

- Difference in ext. Ø: 170 mm - 160 mm =  $\Delta$  10 mm (see p. 9) ;
- $\Delta$  Max. du SC175 = 12 mm → does not require the use of a ring ;
- Complete assembly : SC175.

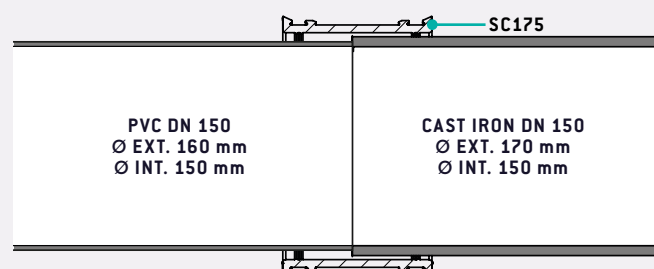

# NORHAM FLEXIBLE COUPLINGS SC

## COUPLINGS & SEALS

### → APPLICATION TO HELP DEFINE COUPLINGS

NORHAM has developed an app designed to help you choose the **NORHAM FLEXIBLE COUPLINGS** you need quickly and easily from any device (smartphone, computer or tablet, for Windows and iOS).

The app can be used with or without an internet connection.



#### STEP 1

Download the application free of charge from the NORHAM website : <http://www.norham.fr/app/> or scan the QR code opposite, using your device (smartphone, computer or tablet).

#### STEP 2

Open the application and fill in the necessary fields (external diameter, DN, materials, type of coupling).

Click on "Find my coupling".



#### STEP 3

Choose the coupling that best suits your needs. In orange, the recommended solution, in blue, the alternative solutions.



#### STEP 4

You'll see the references for your coupling.

Print or save the coupling in your "Favourites".

You can then contact your usual retailer, providing the references.



#### STEP 5

Alternatively, scroll down the page and click on "I'd like a quote". Fill in the fields provided.

Our sales team will contact you as soon as possible.



# NORHAM FLEXIBLE COUPLINGS SC

## COUPLINGS & SEALS

### → INSTALLATION AND USE

#### WARNING

Installation and coupling must be carried out in accordance with the **NORHAM** recommendations set out in ATE-09/0248 and DTA 17.2/20-352\_V2 (downloadable from [www.norham.fr](http://www.norham.fr)).

In all cases, the coupling must be in contact with the pipe for 4 cm on each side.

If there is a risk of shearing, the distance between the two pipes must not exceed 2 cm.

#### INSTALLATION OF SC COUPLINGS WITH BC AND BC-EX RINGS

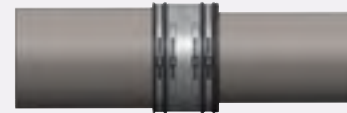

(i) For BC-EX rings only.

1. Loosen the clamps and slide the coupling onto the pipe with the largest external diameter.
2. Slide the ring onto the pipe with the smallest external diameter. The ring should be flush with the edge of the pipe. For BC-EX eccentric rings, ensure that the mark is on the top of the pipe.
3. Align the two pipes and bring them as close together as possible.
4. Slide the coupling onto the bushing until it is flush with the shoulder of the bushing. Tighten the fasteners until they lock (the recommended torque is shown on the coupling label).

#### INSTALLATION OF SC AND DC COUPLINGS



1. Draw a mark on the pipe with the largest external diameter, corresponding to half the width of the coupling.
2. Loosen the clamps and slide the coupling onto the pipe with the largest external diameter.
3. Align the two pipes and bring them as close together as possible.
4. Slide the coupling up to the mark and tighten all the fasteners until they lock (the recommended torque is shown on the coupling label).

#### INSTALLATION OF AC COUPLINGS

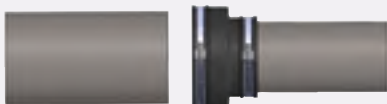



1. Loosen the fasteners.
2. Slide the coupling onto the pipe with the smallest external diameter.
3. Bring the smaller external diameter pipe towards the larger external diameter pipe and bring the larger external diameter pipe as close as possible to the inside shoulder of the coupling.
4. Tighten the fasteners of the coupling until they lock (the recommended torque is shown on the coupling label).

# NORHAM FLEXIBLE COUPLINGS SC

## COUPLINGS & SEALS

### → COUPLINGS : COMMON PRODUCTS



#### PVC / PP - CAST IRON CONNECTIONS

MATERIALS		DN	Ø EXT.		SOLUTIONS	FINAL Δ	CONTINUOUS WATER FLOW
PVC / PP	CAST IRON		PVC / PP	CAST IRON			
		125	125	144	SC150EX-PFF (SC150 + BC08-125EX)	1	YES
		150	160	170	SC175	10	
		200	200	222	SC225EX-PFF (SC225 + BC08-200EX)	0	
		250	250	274	SC290EX-PFF (SC290 + BC16-250EX)	1	
		300	315	326	SC335	11	
		400	400	429	SC445EX-PFF (SC445 + BC16-400EX)	0	

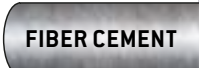

#### PVC / PP - FIBRE CEMENT CONNECTIONS

MATERIALS		DN	Ø EXT.		SOLUTIONS	FINAL Δ	CONTINUOUS WATER FLOW
PVC / PP	FIBRE CEMENT		PVC / PP	FIBRE CEMENT			
		125	125	141	SC150EX-PFF (SC150 + BC08-125EX)	4	YES
		150	160	166	SC175	6	
		200	200	218	SC225EX-PFF (SC225 + BC08-200EX)	4	
		250	250	274	SC290EX-PFF (SC290 + BC16-250EX)	1	
		300	315	328	SC335	13	
		400	400	445	SC465 + BC16-400EX + BC08-429-100	0	

#### PVC / PP - CLAY CONNECTIONS

MATERIALS		DN	Ø EXT.		SOLUTIONS	FINAL Δ	CONTINUOUS WATER FLOW
PVC / PP	CLAY		PVC / PP	CLAY			
		300	315	355	SC365 + BC16-315-100	8	YES
		400	400	492	SC510 + BC16-400EX + BC32-429-100	1	

#### PVC / PP - CONCRETE CONNECTIONS



MATERIALS		DN	Ø EXT.		SOLUTIONS	Δ FINAL	CONTINUOUS WATER FLOW
PVC / PP	CONCRETE		PVC / PP	CONCRETE			
		300	315	400	SC410 + BC16-315-100 + BC24-347-100	5	YES
				420	SC430 + BC24-315-100 + BC24-363-100	9	
		400	400	502	SC510 + BC16-400EX + BC32-429-100	9	
		500	500	628	SC635 + BC32-500-100 + BC32-564-100	0	





# NORHAM FLEXIBLE COUPLINGS SC

## COUPLINGS & SEALS

### PVC / PP - GRP CONNECTIONS

MATERIALS		DN	Ø EXT.		SOLUTIONS	FINAL Δ	CONTINUOUS WATER FLOW
PVC / PP	PRV		PVC / PP	PRV			
		125	125	142	SC150EX-PFF (SC150 + BC08-125EX)	3	YES
		150	160	168	SC175	8	
		200	200	220	SC225EX-PFF (SC225 + BC08-200EX)	2	
		250	250	272	SC290EX-PFF (SC290 + BC16-250EX)	3	
		300	315	324	SC335	9	
		400	400	428	SC445EX-PFF (SC445 + BC16-400EX)	1	

### CLAY - CAST IRON CONNECTIONS

MATERIALS		DN	Ø EXT.		SOLUTIONS	FINAL Δ	CONTINUOUS WATER FLOW
GRÈS	CAST IRON		CLAY	CAST IRON			
		125	159	144	SC162 + BC08-144-80	1	YES
		150	186	170	SC200 + BC08-170-80	0	
		200	242	222	SC250 + BC08-222-80	4	
		250	296	274	SC310 + BC08-274-100	6	
		300	355	326	SC365 + BC08-326-100	13	
		400	486	429	SC495 + BC24-429-100	9	

### CLAY - FIBRE CEMENT CONNECTIONS

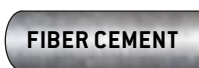
MATERIALS		DN	Ø EXT.		SOLUTIONS	FINAL Δ	CONTINUOUS WATER FLOW
GRÈS	FIBROCIMENT		CLAY	FIBRE CEMENT			
		125	159	141	SC162 + BC08-141-80	2	YES
		150	186	167	SC200 + BC08-167-80	3	
		200	242	218	SC250 + BC08-218-80	8	
		250	296	274	SC310 + BC08-274-100	6	
		300	355	328	SC365 + BC08-328-100	11	
		400	486	442	SC495 + BC16-442-100	12	

ALL THESE COUPLING SOLUTIONS ARE COVERED BY OUR CERTIFICATIONS



ARE YOU IN A CONFIGURATION THAT DIFFERS  
FROM THE COMMON COUPLINGS ?

Download our new NORHAM FLEXIBLE COUPLINGS COUPLING DEFINITION HELP  
application



[www.norham.fr/app/](http://www.norham.fr/app/)

# NORHAM FLEXIBLE COUPLINGS SC

## COUPLINGS & SEALS

### → CORRESPONDENCE BETWEEN DN AND EXTERNAL DIAMETERS

TYPE DE CANALISATION		DN	100	125	140	150	175	200	225	250	300	350	375	400	450	500	550	600	700	750	
ACIER			114	140		168	194	219		273	324	356		406	457	508	559	610	711	762	
TUBE ANNELE	POLIECO	ECOPAL, ECOBOX						250			350			406	457	508	559	610	711	762	
	POLYPIPE HYDROTUB	HYDRO 8				176				265		353		435	460	514	570			675	
		WEHOLITE (4KN/m)													450	510	558			678	840
		WEHOLITE (2KN/m)																		658	812
	URALITA	SANECOR (PVC annelé SN8)									315			400		539			649		
	REHAU	RAUVIA								290	349	414		468							
	ELYDAN	ULTRA RIB 2 SN10/16				170		225		280	335			450		560					
	HEGLER	AQUATUB-EU (ATEC)				175		235		294	353			464							
		AQUATUB				175		235		294	353			464		579			693		
	SYSTEME GROUPE France	MAGNUM, BIG-DREN, HYDRO 16		125		160		200	250	284	315	338	400		452	500	565	630	701	800	
SGK																					
FRÄNKISCHE	ROBUKAN SN8/16				174		235		294	348			461		571			684			
	AQUA-PIPE				174		235		292	346	399		461		587			694			
FIBRO CIMENT	partie brute		116	144		171		223		278	332	384		445	494	549		658	768		
	partie usinée		115	141		167		219		274	329	378		442	486	540		648	756		
BÉTON	PLATTARD	TRADITEC									420			530		650		760			
		TEVOLIS									420			530		650		760			
	ALKERN	Tuyau Armé									400			512		640		750			
	STRADAL	135A									404			510		630		750			
		Tuyau Armé TCR														650		760	880		
	BONNA SABLA	Tuyau Armé 135 A								396				502		606		724	840		
		Non Armé 90B/135B Usine Diou (03)*								400				508		622		746			
	LPB	ASSAINOR, ECO								370				465		605		715			
	NORMANDYTUB	135A								400				504		628		752			
	URVOY	90A - 135A								396				504		628		752			
BETONS LIBAUD	135F									418				519		650		770			
	135A																				
PMR	135F									421			524		644		768				
FONTE	PAM	INTEGRAL, PLUVIAL	118	144		170		222		273	325	377		428	479	531		633	737		
		SMU S, SME, SMU plus	110	135		160		210		274	326			429		532		635			
	ELECTROSTEEL	Fonte ductile (EN545- ISO 2531)	118	144		170		222		274	326	378		429	480	532		635	738		
	SERTUBI	Fonte ductile	144		170		222	274	326	378		429		480	532		635	738	842		
	BUDERUS	Fonte ductile	118	144		170		222		274	326	378		429	480	532		635	738		
	Fonte ductile	118			170		222		274	326	378		429	480	532		635	738			
GRÈS	HEPWORTH (WAVIN)	EUROTOP	122			178					358										
		DENSEAL				192		249	273	310	364		460	482	547	609		715			
	NAYLOR	DENSELEEVE	131			187		254	278	318	380										
		DENLOK				208		271	293	357	412			552	585	639		758	855		
	STEINZEUG-KERAMO	Assemblage F	131	159		186		242													
Assemblage C (classe 95 - 120 - L)																581		687			
Assemblage C (classe 160)									299	355	417		486	548	609		725				
	Assemblage C (classe 200-240)						254	278	318	376			492						862		
PEHD	Polyéthylène	110	125	140	160	180	200	225	250/280	315	355		400	450	500	560	630	710			
PVC	PVC	100/110	125	140	160	180	200	225	250	315			400	450	500		630	710			
PRV	HOBAS	Série 1 et 2				168		220		272	324	376		427	478	530		616	718		
		Série 3												401		501					
	FLOWTITE				168		221		272	325	377		428	479	531		618	720			
HPS	SUBOR®								273	325	377		428	479	531		618	720			
PP	DYKA	AWADUKT PP10	110	125		160		200		250	315			400		500					
	POLOPLAST	POLO-ECO plus SN8/12	110	125		160		200		250	315			400		500					
	PIPELIFE	PP Master	110	125		160		200		250	315			400		500					
TYPE DE CANALISATION		DN	100	125	140	150	175	200	225	250	300	350	375	400	450	500	550	600	700	750	

# NORHAM FLEXIBLE COUPLINGS SC

## COUPLINGS & SEALS

800	850	900	1000	1030	1050	1100	1200	1300	1350	1400	1500	1600	1650	1700	1800	1900	2000	DN	TYPE DE CANALISATION
813	864	914	1016				1220			1420	1520	1620		1720	1820		2020		ACIER
930				1200														ECOPAL, ECOBOX	POLIECO
																		HYDRO 8	
		1012			1172		1346		1506		1662		1810		1998		2230	WEHOLITE (4kN/m)	POLYPIPE
		962			1134		1316		1474		1636		1786		1976		2180	WEHOLITE (2kN/m)	HYDROTUB
855			1072				1220											SANECOR (PVC annelé SN8)	URALITA
																		RAUVIA	REHAU
																		ULTRA RIB 2 SN10/16	ELYDAN
																		AQUATUB-EU (ATEC)	
																		AQUATUB	HEGLER
935	1000			1200														MAGNUM, BIG-DREN, HYDRO 16	SYSTEME GROUPE
			1092				1312			1542	1642	1746		1850	1954		2162	SGK	France
																		ROBUKAN SN8/16	FRÄNKISCHE
																		AQUA-PIPE	
878																			partie brute
864																			partie usinée
990			1240				1470											TRADITEC	PLATTARD
984			1230				1460			1680	1800	1920			2160		2390	Tuyau Armé	ALKERN
980			1220				1470											135A	STRADAL
1000		1120	1270			1380	1480	1620		1720	1820	1940			2160		2400	Tuyau Armé TCR	
980		1080	1200							1680	1800	1920			2160		2400	Tuyau Armé 135 A	BONNA SABLE
																		Non Armé 90B/ 135B Usine Diou (03)*	
930																		ASSAINOR, ECO	LPB
970			1220															135A	NORMANDYTUB
976			1200				1440											90A - 135A	URVOY
																		135F	
988			1224				1471											135A	BETONS LIBAUD
																		135F	PMR
840		943	1046			1149	1252			1459	1562	1665			1871		2078	INTEGRAL, PLUVIAL	PAM
																		SMU S, SME, SMU plus	
842		945	1048															Fonte ductile (EN545- ISO 2531)	ELECTROSTEEL
842	945	1048																Fonte ductile	SERTUBI
842		945	1048																BUDERUS
842		945	1048			1152	1255											Norme Anglaise BS4772	Fonte ductile
																		EUROTOP	HEPWORTH (WAVIN)
																		DENSEAL	
950		1080	1193			1307	1430											DENSLEEVE	NAYLOR
																		DENLOK	
																		Assemblage F	
																		Assemblage C	
964			1273				1457			1600								(classe 95 - 120 - L)	STEINZEUG-KERAMO
																		Assemblage C (classe 160)	
																		Assemblage C (classe 200-240)	
800		900	1000				1200												Polyéthylène
800																			PVC
820		924	1026															Série 1 et 2	
																		Série 3	HOBAS
822		924	1026			1128	1230	1332		1434	1536	1638		1740	1842	1944	2046		FLOWTITE
822		924	1026			1128	1230	1332		1434	1536	1638		170	1842	1944	2046		HPS
																		SUBOR®	
																		AWADUKT PP10	DYKA
																		POLO-ECO plus SN8/12	POLOPLAST
																		PP Master	PIPELIFE
800	850	900	1000	1030	1050	1100	1200	1300	1350	1400	1500	1600	1650	1700	1800	1900	2000	DN	TYPE DE CANALISATION

# NORHAM FLEXIBLE COUPLINGS SC

COUPLINGS & SEALS

## → CASE STUDY



### 1 NORHAM FLEXIBLE COUPLINGS WITH ECCENTRIC RING To maintain the flow of water at Perros Guirec

	CONDITIONS
<b>SITE</b>	Perros Guirec (France)
<b>BESOIN</b>	Need for a water flow-preserving coupling between a <b>DN 400 PP pipe</b> (external diameter 400 mm) and a <b>DN 400 concrete pipe</b> (external diameter 502 mm).
<b>SOLUTION</b>	An eccentric <b>NORHAM FLEXIBLE COUPLINGS SC + BC-EX</b> was installed. For this job, it consisted of an SC510 coupling with a <b>BC16-400EX eccentric compensation ring</b> for the preservation of the water flow, as well as a BC32-429-100 ring.



#### LÉGENDES

- 1 Installation of the eccentric coupling and installation of the pipe.
- 2 Eccentric coupling installed.
- 3 View of the inside of the pipes after the eccentric coupling was installed; there was **no break in the water flow**.

#### PROJECT MANAGEMENT

FITTER : CEGELEC TP.



Find all our case studies on our website :  
[www.norham.fr](http://www.norham.fr)

# NORHAM FLEXIBLE COUPLINGS SC

## COUPLINGS & SEALS

### → OTHER NORHAM SOLUTIONS

#### T-SADDLE MULTI



T-SADDLE MULTI  
ON CONCRETE PIPE



T-SADDLE MULTI  
ON CORRUGATED PIPE

Saddles for multimaterial branches for all types of collector valves from DN 400 to DN 1200.



DOWNLOAD DOCUMENTATION

#### T-SADDLE



Saddles for multimaterial branches for all smooth pipes.



DOWNLOAD DOCUMENTATION



Z.A DRUISIEUX - 130 RUE DES SAULES  
26260 SAINT DONAT SUR L'HERBASSE - FRANCE  
TÉL : 33 (0) 4 75 45 00 00 - [norham@norham.fr](mailto:norham@norham.fr)  
[www.norham.fr](http://www.norham.fr)



[www.norham.fr](http://www.norham.fr)